

# INSTALLATION INSTRUCTIONS FOR AERODYNAMIC TT BRAKE SYSTEM

## WARNING - to avoid serious injuries

• Improper use of your bicycle's brake system may result in a loss of control or an accident, which could lead to a severe injury. Because each bicycle may handle differently, be sure to learn the proper braking technique (including brake lever pressure and bicycle control characteristics) for your bicycle. Consult your bicycle dealer and the bicycle's owners manual, and practice your riding and braking technique.

• Securely tighten the caliper brake mounting nuts to the specified tightening torque. For recessed nut type brakes: Use recessed nuts of the appropriate length which can be turned six times or more; when re-installing, apply sealant (locking adhesive) to the nut threads.

• If the nuts become loose and the brakes fall off, they could get caught up in the bicycle and the bicycle may fall over. Particularly if this happens with the front wheel the bicycle may be thrown forward and serious injury could result.

• Brakes designed for use as rear brakes should not be used as front brakes and vice versa.

• Obtain and read the service instructions carefully prior to installing the brakes. Loose, worn, or damaged parts may cause serious injury.

• Be careful not to allow any oil or grease to get onto the brake shoes, if oil or grease gets on the pads, the pads should be replaced, and the braking surface of the rims should be cleaned carefully, otherwise the brakes may not work properly.

• Always make sure that the front and rear brakes are working correctly before you ride the bicycle.

• The required braking distance will be longer during wet weather. Reduce your speed and apply the brakes early and gently.

• If the road surface is wet, the tires will skid more easily. If the tires skid, you may lose control of the bicycle. To avoid this, reduce your speed and apply the brakes early and gently.

• Read these Technical Service Instructions carefully, and keep them in a safe place for later reference.

## NOTE:

• If using standard TRP brake pads in combination with ceramic or carbon fiber rims, the brakes shoes will wear more quickly than normal. Pads specifically designed for carbon fiber rim surfaces are available from TRP.

• If the brake pads have worn down until the grooves are no longer visible, they should be replaced.

• Parts are not guaranteed against natural wear or deterioration resulting from normal use or crash damage.

• For any questions regarding methods of handling or maintenance, please contact the original place of purchase.

## A - Tools

5mm Allen Key – For mounting bolts  
4mm Allen Key – For brake pad adjusting bolts  
2.5mm Allen Key – For Noodle and Clamping Bolt adjustment  
2mm Allen Key – For brake adjustment screws

## B - Instructions brake set up – ( T920 / T820 )

The T920/820 brakes are center pull brakes, the main cable pulls a straddle carrier link assembly which actuates the brake arms.

1. Mount the left and right side caliper arm first. Apply a thin coating of grease to the pivot on the frame or fork, insert the brake spring pin into the hole in the frame as you slide the brake arm onto the pivot. Secure with 5mm mounting bolt.

**Tightening torque 6-8 nm.**

2. Install left and right bolt cover cap by snapping into place. (Alloy T920 or Plastic T820)

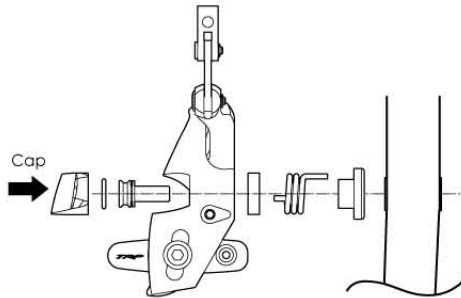

## C - Adjustment screw troubleshooting

1. Thread the brake cable into the straddle carrier link.  
2. The straddle carrier link is fixed to the end of the right brake arm, clip the open end of the carrier link onto the pin in the left arm. (This open end will be your release when you need to disconnect the brake to remove the wheel from the frame.)  
3. Squeeze the brake arms together while pulling the cable tight. Tighten the cable with 2.5 mm allen bolt on the side of the straddle carrier. **Tightening torque ???**

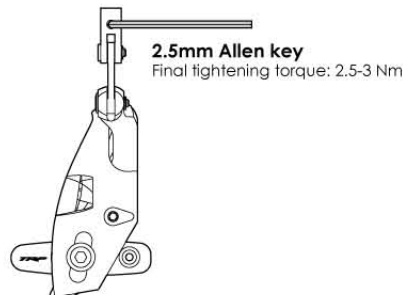

## D - Cable connection

Balance the Brakes – Using the 2mm adjustment screws in the right and left brake arms make small changes with the adjustment screw until the brake is centered.

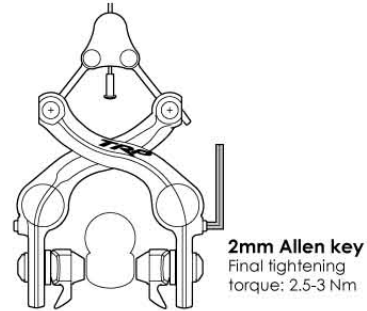

## E - A note about rim widths

While traditional rim width are generally 19-22mm at the braking surface, many high performance manufacturers are moving to wider >25mm cross section rims. These rims require a wider spacing for the brakes to align properly and function correctly. you can gain the additional spacing needed to run wider rims. Keep in mind that insure the best performance you will need to reinstall the washer when using more traditional, narrow rims.

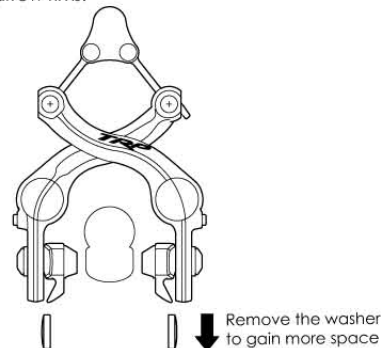

## F - Adjustment Screw Troubleshooting

On some earlier models, the spring tension screw can slip behind or to the side of the spring adjuster plate. This can cause the screw to jam and it will be impossible to adjust the spring tension to align the calipers. Fortunately it is an easy fix. Using a small screwdriver, pry off the dust cap and remove the spring. Back the adjusting screw all the way out until the adjuster plate moves freely. Using a small pointed object slide the adjuster plate counter-clockwise until the adjusting screw bolt hole is visible, then thread the adjuster screw in until the screw contacts the notch in the adjuster plate. See photos below for details:

## G - Check

Depress the brake lever about 10 times as far as the handlebar and check that everything is operating correctly and that the shoe clearance is correct before using the brakes.

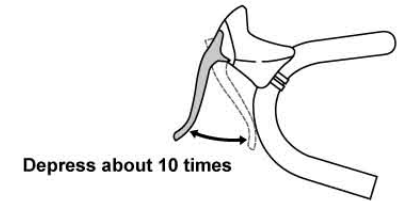

## Replacement of the cartridge pad

Remove the fixing bolt. Remove the pad by sliding it along the groove of the pad holder.

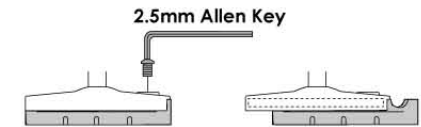

There are two different types of pad and pad holder to be used in the left and right positions respectively. Slide the new pad into the grooves on the pad holders while taking note of the correct directions and bolt hole positions.

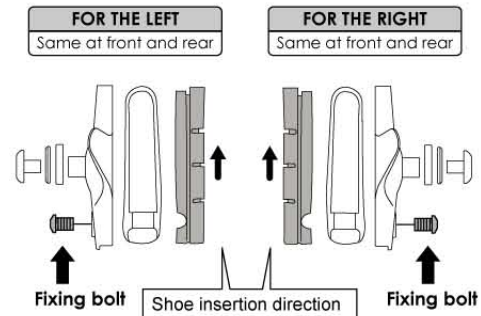

Tighten the fixing bolt. **Tightening torque: 1-1.5 Nm.**

## QUESTIONS?

For questions about setup, usage or general inquiries, please e-mail or call toll free at:

**TRP Brakes**  
info@trpbrakes.com  
1-877-807-4162  
www.trpbrakes.com